

Power Distribution Unit



Basic Power Distribution Units (PDU)



Part Number	Series	Product Description
LN-PRZ-SGT-1U3P-SC	Basic PDU	3xDIN49440 socket schuko power strip, 19" 1U, aluminium housing, 1x16A cct breaker, 4000 Watt, 250V AC, 3x1.5mm ² , 2,5m cable, DIN 49441 plug, CE approval

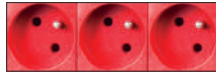

Part Number	Series	Product Description
LN-PRZ-SGT-1U3P-UPS	Basic PDU	3xUPS type french UTE socket power strip, 19" 1U, aluminium housing, 1x16A cct breaker, 4000 Watt, 250V AC, 3x1.5mm ² , 2,5m cable, DIN 49441 plug, CE approval



Part Number	Series	Product Description
LN-PRZ-SGT-1U6P-SC	Basic PDU	6xDIN49440 socket schuko power strip, 19" 1U, aluminium housing, 1x16A cct breaker, 4000 Watt, 250V AC, 3x1.5mm ² , 2,5m cable, DIN 49441 plug, CE approval



Part Number	Series	Product Description
LN-PRZ-SGT-1U6P-UPS	Basic PDU	6xUPS type french UTE socket power strip, 19" 1U, aluminium housing, 1x16A cct breaker, 4000 Watt, 250V AC, 3x1.5mm ² , 2,5m cable, DIN 49441 plug, CE approval



Part Number	Series	Product Description
LN-PRZ-SGT-2U9P-SC	Basic PDU	9xDIN49440 socket schuko power strip, 19" 2U, aluminium housing, 1x16A cct breaker, 4000 Watt, 250V AC, 3x1.5mm ² , 2,5m cable, DIN 49441 plug, CE approval



Part Number	Series	Product Description
LN-PRZ-SGT-2U12P-SC	Basic PDU	12xDIN49440 socket schuko power strip, 19" 2U, aluminium housing, 1x16A cct breaker, 4000 Watt, 250V AC, 3x1.5mm ² , 2,5m cable, DIN 49441 plug, CE approval

Basic Power Distribution Units (PDU)



Part Number	Series	Product Description
LN-PRZ-ONF-1U6P-UK	Basic PDU	6xBS1363 UK socket power strip, 19" 1U, aluminium housing, 16A illuminated on/off switched, 3250 Watt, 250V AC, 3x1.5mm ² , 2,5m cable, 13A BS1363 plug, CE approval



Part Number	Series	Product Description
LN-PRZ-ONF-2U12P-UK	Basic PDU	12xBS1363 UK socket power strip, 19" 2U, aluminium housing, 16A illuminated on/off switched, 3250 Watt, 250V AC, 3x1.5mm ² , 2,5m cable, 13A BS1363 plug, CE approval



Part Number	Series	Product Description
LN-PRZ-SGT-1U6P-IE	Basic PDU	6xIEC 320 C13 socket power strip, 19" aluminium housing, 1x16A cct breaker, 4000 Watt, 250V AC, 2,5m cable, DIN 49441 plug, CE approval



Part Number	Series	Product Description
LN-PRZ-SGT-1U9P-IE	Basic PDU	9xIEC 320 C13 socket power strip, 19" aluminium housing, 1x16A cct breaker, 4000 Watt, 250V AC, 2,5m cable, DIN 49441 plug, CE approval



Part Number	Series	Product Description
LN-PRZ-ONF-1U8P-SC	Basic PDU	8xDIN49440 socket schuko power strip, 19" 1U, aluminium housing, 16A illuminated on/off switched, 4000 Watt, 250V AC, 3x1.5mm ² , 2,5m cable, DIN 49441 plug, CE approval

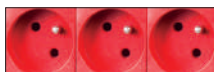
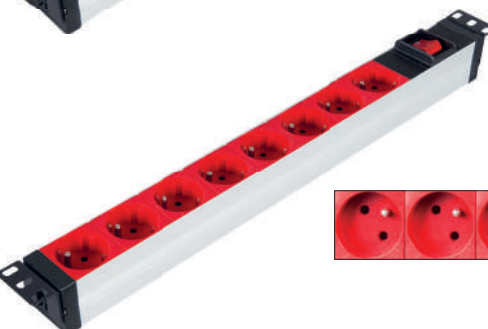

Part Number	Series	Product Description
LN-PRZ-ONF-1U8P-UPS	Basic PDU	8xUPS type french UTE socket power strip, 19" 1U, aluminium housing, 16A illuminated on/off switched, 4000 Watt, 250V AC, 3x1.5mm ² , 2,5m cable, DIN 49441 plug, CE approval

Basic Power Distribution Units (PDU)



Part Number	Series	Product Description
LN-PRZ-AKK-1U6P-SC	Basic PDU	6xDIN49440 socket schuko surge protection power Strip, 19" 1U, aluminium housing, 16A lighted on/off switched, 4000 Watt, 250V AC, 3x1.5mm ² , 2,5m cable, DIN 49441 plug, CE approval



Part Number	Series	Product Description
LN-PRZ-AMP-1U6P-IE	Basic PDU	6xIEC 320 C13 socket PDU with Ampermeter Display, 19" 1U, aluminium profile frame, 1x16A MCB, 4000 Watt, 250V AC, 3x2.5mm ² , 3m cord with IEC60309 plug (16A 2P+E), CE mark



Part Number	Series	Product Description
LN-PRZ-ONF-1U3P-SC	Basic PDU	3xDIN49440 socket schuko power strip, 10" 1U, aluminium housing, 16A illuminated on/off switched, 4000 Watt, 250V AC, 3x1.5mm ² , 2,5m cable, DIN 49441 plug, CE approval



Part Number	Series	Product Description
LN-PRZ-ONF-1U3P-UK	Basic PDU	3xBS1363 UK socket power strip, 10" 1U, aluminium housing, 16A illuminated on/off switched, 3250Watt, 250V AC, 3x1.5mm ² , 2,5m cable, 13A BS1363 plug, CE approval

Basic Power Distribution Units (PDU)



Part Number	Series	Product Description
LN-PRZ-SGT-4224-SC	Basic PDU	24xDIN49440 socket schuko power strip, triple circuit (8+8+8), aluminium housing, 3pcs. 1x10A cct breaker, 250V AC, for 42U, 45U, 47U cabinet height, no cable, ready cable connection point



Part Number	Series	Product Description
LN-PRZ-SGT-4224-IE	Basic PDU	24xIEC 320 C13 socket power strip, triple circuit (8+8+8), aluminium housing, 3pcs. 1x10A cct breaker, 250V AC, for 42U, 45U, 47U cabinet height, no cable, ready cable connection point.



Part Number	Series	Product Description
LN-PRZ-SGT-4218-SC	Basic PDU	18xDIN49440 socket schuko power strip, double circuit (9+9), aluminium housing, 2pcs. 1x16A cct breaker, 250V AC, for 42-45-47U cabinet height, no cable, ready cable connection point

Basic Power Distribution Units (PDU)



Part Number	Series	Product Description
LN-PRZ-SGT-4218-IE	Basic PDU	18xIEC 320 C13 socket power strip, double circuit (9+9), aluminium housing, 2pcs. 1x16A cct breaker, 250V AC, for 42-45-47U cabinet height, no cable, ready cable connection point



Part Number	Series	Product Description
LN-PRZ-SGT-3618-SC	Basic PDU	18xDIN49440 socket schuko power strip, double circuit (9+9), aluminium housing, 2pcs. 1x16A cct breaker, 250V AC, for 36U cabinet height, no cable, ready cable connection point.



Part Number	Series	Product Description
LN-PRZ-SGT-3618-IE	Basic PDU	18xIEC 320 C13 socket power strip, double circuit (9+9), aluminium housing, 2pcs. 1x16A cct breaker, 250V AC, for 36U cabinet height, no cable, ready cable connection point

Basic Power Distribution Units (PDU)



Part Number	Series	Product Description
LN-PRZ-SGT-2612-SC	Basic PDU	12xDIN49440 socket schuko power strip, double circuit (6+6), aluminium housing, 2pcs. 1x16A cct breaker, 250V AC, for 26U cabinet height, no cable, ready cable connection point



Part Number	Series	Product Description
LN-PRZ-SGT-2612-IE	Basic PDU	12xIEC 320 C13 socket power strip, double circuit (6+6), aluminium housing, 2pcs. 1x16A cct breaker, 250V AC, for 26U cabinet height, no cable, ready cable connection point

Power Distribution Units (PDU, vertical) Monitoring and Managed Intelligent

IEC 320 C13
lockable and
C19 socket
combinations



Hydraulic magnetic
circuit breakers



Part Number	Series	Product Description
LN-PRZ-IZP-DM24-IE	Monitoring PDU	24xIEC 320 (20xC13 + 4xC19) socket, MONITORED IP PDU with LCD Display, ZeroU, metal body, 2pcs 1P 16A hydraulic circuit breaker, 8000 Watt, 250V AC, 3x6.0mm ² , 3m cord with IEC 60309 plug (32A 2P+E), CE mark, daisy-chain function up to 1 master 4 slave units, remote monitoring port, PDU based monitoring

IEC 320 C13
lockable and
C19 socket
combinations



Hydraulic magnetic
circuit breakers

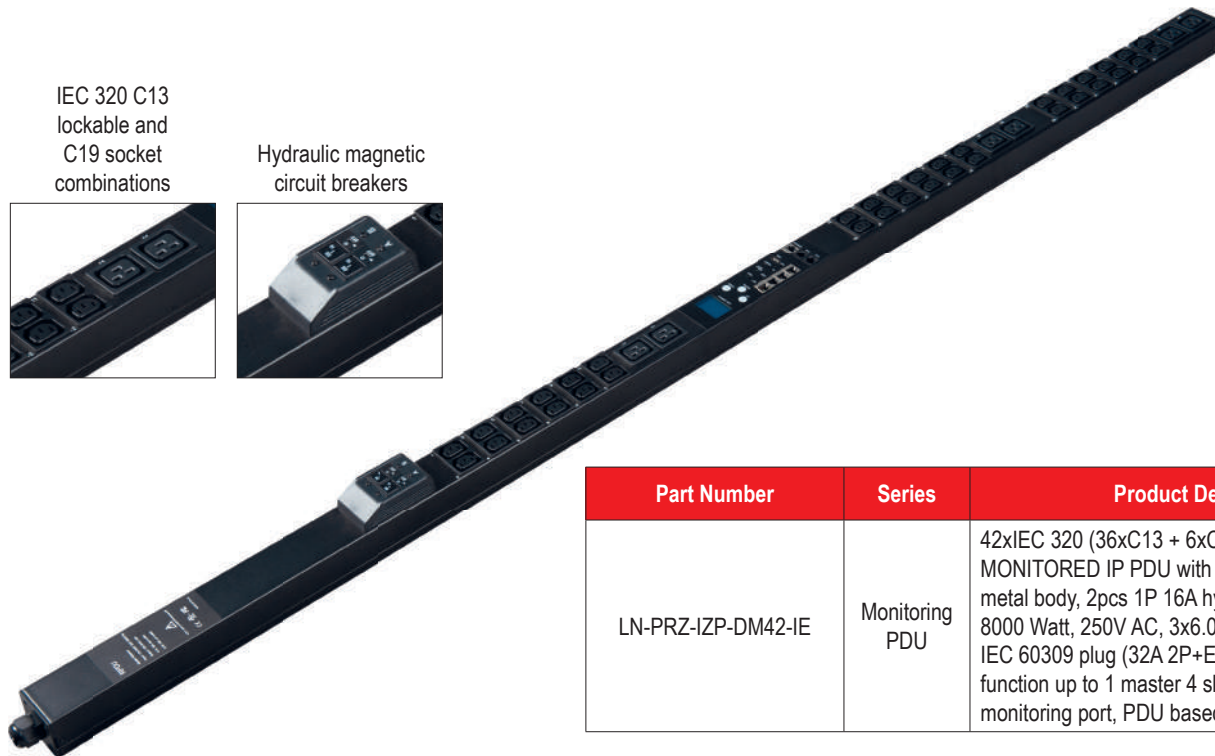

Part Number	Series	Product Description
LN-PRZ-IZP-DM42-IE	Monitoring PDU	42xIEC 320 (36xC13 + 6xC19) socket, MONITORED IP PDU with LCD Display, ZeroU, metal body, 2pcs 1P 16A hydraulic circuit breaker, 8000 Watt, 250V AC, 3x6.0mm ² , 3m cord with IEC 60309 plug (32A 2P+E), CE mark, daisy-chain function up to 1 master 4 slave units, remote monitoring port, PDU based monitoring

Power Distribution Units (PDU, vertical) Monitoring and Managed Intelligent

IEC 320 C13
lockable and
C19 socket
combinations



Hydraulic magnetic
circuit breakers

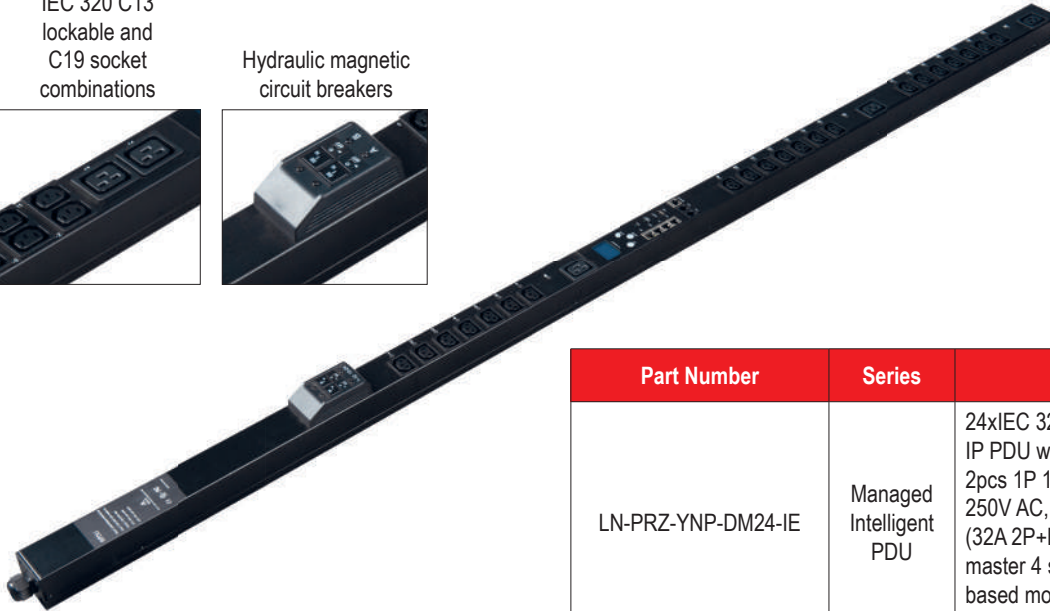

Part Number	Series	Product Description
LN-PRZ-YNP-DM24-IE	Managed Intelligent PDU	24xIEC 320 (20xC13 + 4xC19) socket, MANAGED IP PDU with LCD Display, ZeroU, metal body, 2pcs 1P 16A hydraulic circuit breaker, 8000 Watt, 250V AC, 3x6.0mm ² , 3m cord with IEC 60309 plug (32A 2P+E), CE mark, daisy-chain function up to 1 master 4 slave units, Remote Monitoring port, outlet based monitoring and remote switch on/off function per socket or group of sockets



Optional
Accessory

Multimeter display

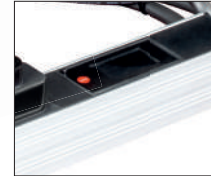

IEC 320 C13
lockable and
C19 socket
combinations



Lockable sockets



Part Number	Series	Product Description
LN-PRZ-AMP-DM24-IE	Multimeter Display PDU	24xIEC 320 (20xC13 + 4xC19) socket PDU with multimeter display, ZeroU, aluminium profile frame, 2x16A MCB, 8000 Watt, 250V AC, 3x6.0mm ² , 3m cord with IEC 60309 plug (32A 2P+E), CE mark, locking on sockets standard on both C13 and C19. Along with multimeter display other metering functions are added, V, A, W, kW, PF, temperature probe and sensing, total operating time.

Locking Cord Accessories	
Part Number	Product Description
LN-CORD-C13C14-075	C13-C14 Locking Cord 0,75m
LN-CORD-C19C20-075	C19-C20 Locking Cord 0,75m
LN-CORD-C13C14-100	C13-C14 Locking Cord 1,0m
LN-CORD-C19C20-100	C19-C20 Locking Cord 1,0m
LN-CORD-C13C14-150	C13-C14 Locking Cord 1,5m
LN-CORD-C19C20-150	C19-C20 Locking Cord 1,5m

Power Distribution Units (PDU, vertical) Monitoring and Managed Intelligent

Main functions	Product series	
	IZP series	YNP series
Accurate measurement of total energy consumption	✓	✓
Total working voltage metering	✓	✓
Total load current metering	✓	✓
Total power metering	✓	✓
Power factor monitoring	✓	✓
Temperature & humidity monitoring	✓	✓
Outlet current metering		✓
Outlet power metering		✓
Threshold setting of outlet current		✓
Accurate measurement of outlet energy consumption		✓
Outlet switching		✓
Delay setting of outlet sequential switching		✓

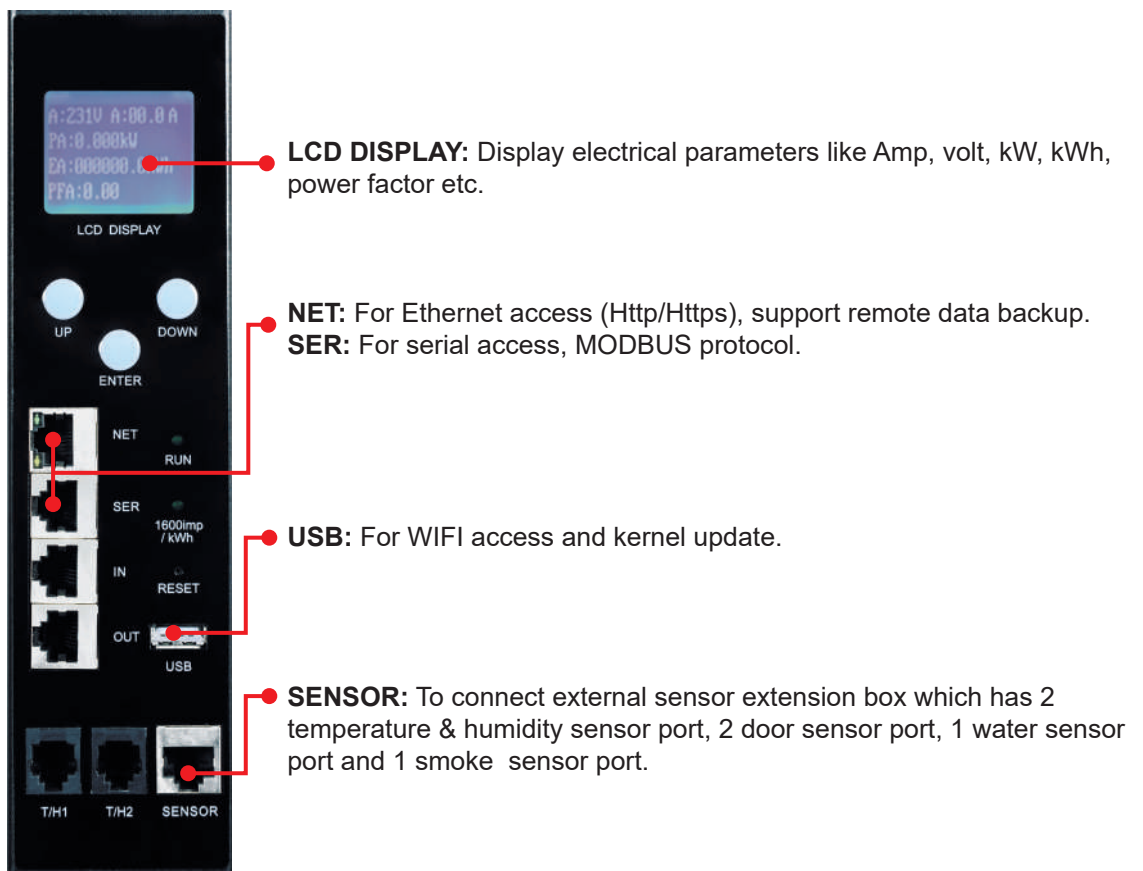

Configurated PDU

PDU Components

Aluminium profile 19"

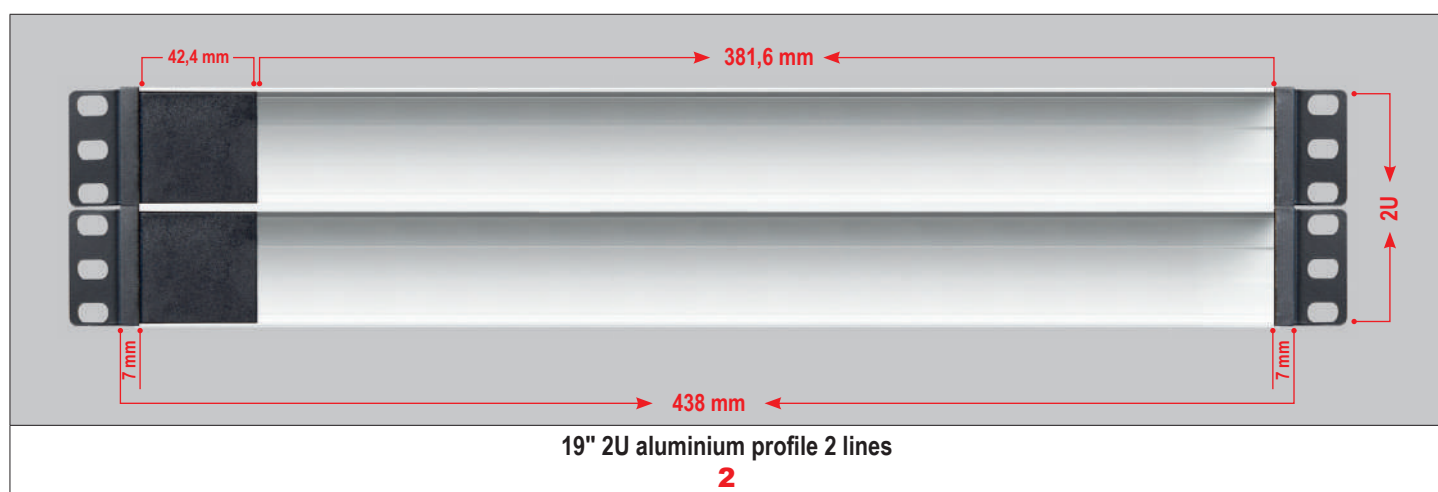
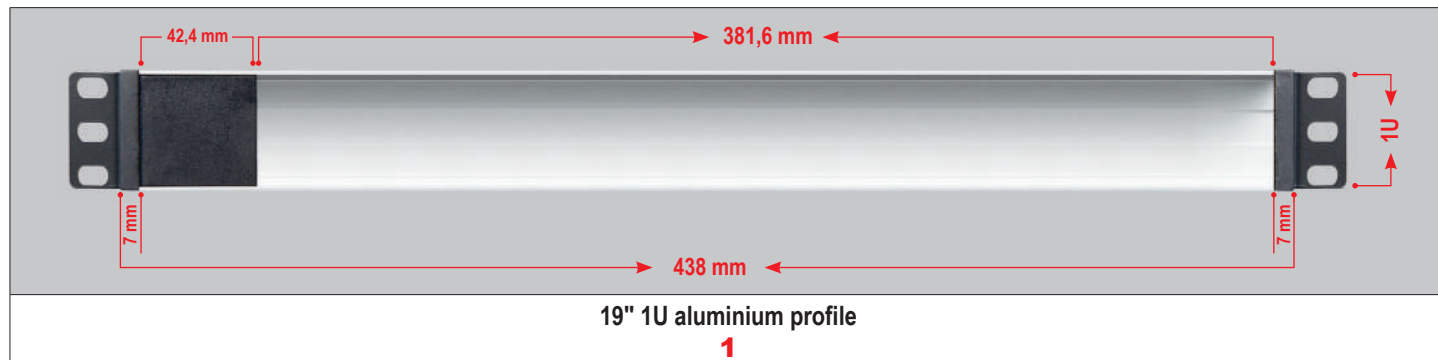



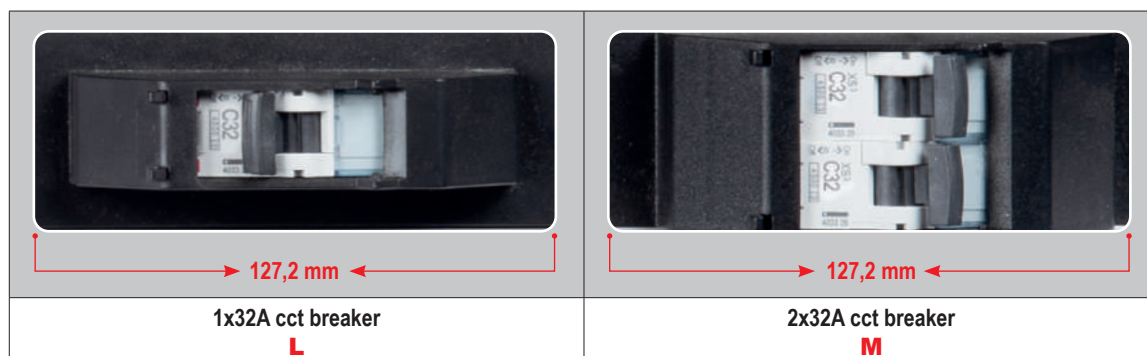
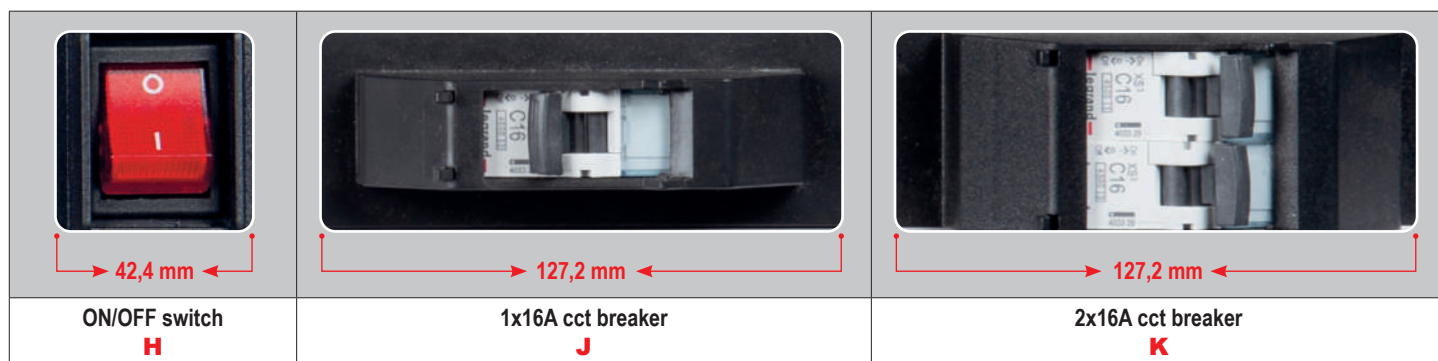

On/off switch and circuit breakers







Configurated PDU





PDU Components



Power indicators and protection devices

			
42,4 mm	42,4 mm	42,4 mm	42,4 mm
Resettable thermal circuit breaker with power indicator led A	Power indicator led B	Surge protection (L-N) with protection indicator led C	Replaceable 5x20 mm fast fuse D

			
42,4 mm	42,4 mm	42,4 mm	84,8 mm
Power & reverse polarity indicator leds + Surge protection (L-N, L-PE, N-PE) with protection & earth fault indicator leds E	Surge protection (L-N, L-PE, N-PE) with power & protection indicator leds F	Surge protection (L-N, L-PE, N-PE) with power & protection indicator leds F	Digital current meter with overload alarm buzzer G

Socket type

				
53 mm	42,4 mm	42,4 mm	42,4 mm	53 mm
BS1363 UK socket (UK)	UPS type french UTE socket (FR)	DIN49440 schuko socket (SC)	IEC 320 C13 socket (C13)	IEC 320 C19 socket (C19)

	
63,6 mm	127,2 mm
2x IEC 320 C13 socket (2C13)	4x IEC 320 C13 socket (4C13)

Configurated PDU

PDU Components

Plastic Closing Parts

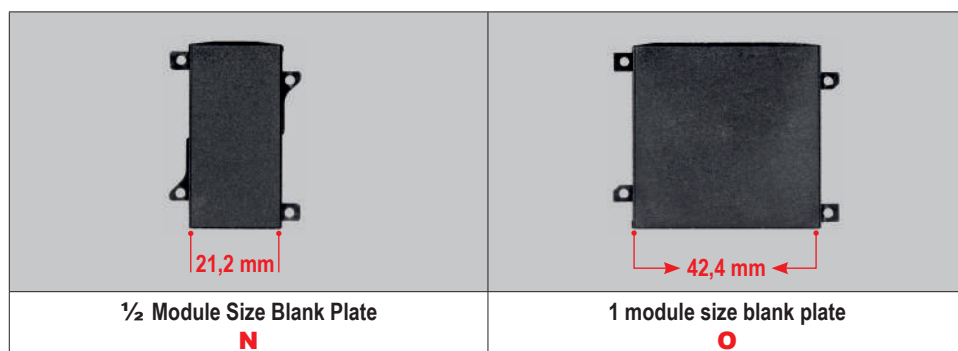

Plug types

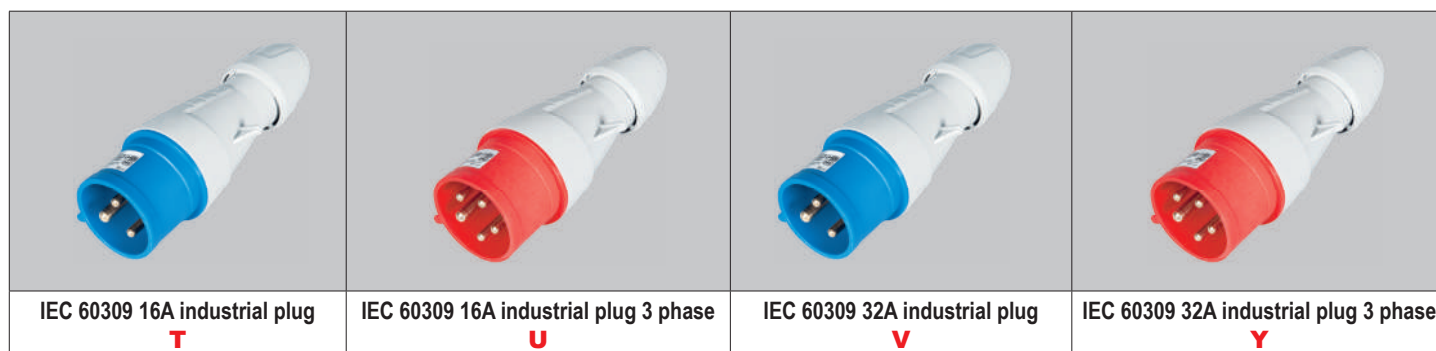

Configurated PDU

Part Nr Sequence and Explanation





Part Nr Sequence	
LN-PRZ-XU-protection-sockets and combinations of sockets, blank cover plate, plug type	
LN	Fixed character defining LN as Lande and PRZ as power distributiun unit.
XU	X is the U character, defined the PDU is 1U or 2U, just change the X with 1 or 2.
PROTECTION	Select fro A to M listed above, you can even use multiple of those example Ampermeter display and On-off switch, then use + in between example G + H.
SOCKET SELECTION	Schuko SC- UTE UPS pin French Type Socket FR, BS1363 UK, C13, C19, 2C13, 4C19 etc or multiples of those.
BLANK COVER PLATE	After putting the sockets, remaining spaces will be closed by N or O- or Multiple combinations of those or with + you can add.
PLUG	The plug at the power connection to be selected like C14 Plug P C20 Plug Q UK Plug R Schuko Plug S 16A Single Phase Industrial Plug T 16A 3 phase Industrial Plug U 32A Single Phase Industrial Plug V 32A 3 phase Industrial Plug Y
NOTES	* In standard the PDU has 3 meter power cable. **There is power cable entry terminal, one piece of 1 full module size blank plate "O" already exists on 1 or 2 selection of aluminium housing where power cable to the related electrical hardware connects under the closing plate. We provide 381,6 mm available configuration space for you considering this fixed blank plate. *** You can make your own configuration, however Lande team have to review and approve the technical compatibility, that means your configurated PDU orders are subject to be reviewed and if technically ok then to be quoted.

Example Part Numbers	
Which we have configured	LN-PRZ-1U-H-6SC+2C13-N-S this part number configuration says LANDE PDU 1U with on/off switch-6 schuko sockets + 2C13 sockets with one small blank closing- with schuko DIN 49441 Plug Lets make aritmetically a calculation; 6 pcs SC sum is $6 \times 42,4 = 254,4$ mm 1 pcs 2C13 is 63,6 mm 1 pcs on/off switch 42,4mm 1 pcs small blank closing 21,2 mm
Validating if configuration fits	$254,4 + 63,6 + 42,4 + 21,2 = 381,6$ mm which as you see that fits to standard 19" 1 U sizing



All those configurations are online at
www.lande.com.tr/configurator.html
 Please scan the qr code to configurate your PDU.

PDU 19" Mounting Bracket Modularity and Options of Assembly

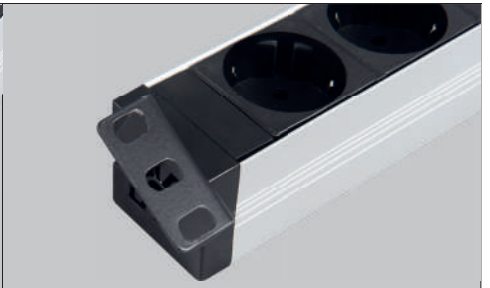
		
PDU bracket modularity 20 variation of bracket assembly	Shipping configuration	PDU bracket side front assembly
		
PDU bracket side rear assembly	PDU bracket rear assembly	PDU bracket angled assembly



CONTACT DETAILS

Headquarters

Address:

Merve Mah. Gazi Cad. No: 17 **Phone:** +90 216 312 26 53
Sancaktepe - İstanbul / TURKEY **Fax** : +90 216 312 09 09

Factory

Address:

20. Cadde No: 14 Eskişehir **Phone:** +90 222 236 24 66 pbx
Organize San. Bölge. 26110 **Fax** : +90 222 236 13 53
Eskişehir / TURKEY

www.lande.com.tr | sales@lande.com.tr

